

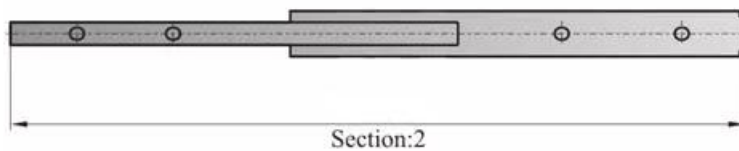

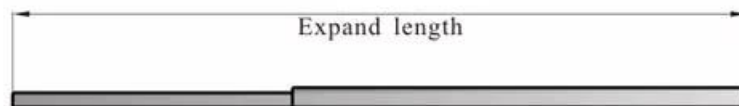

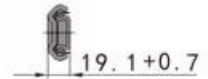

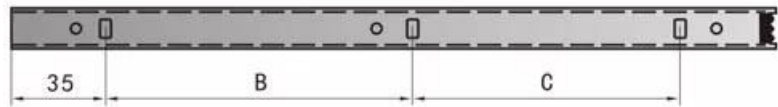
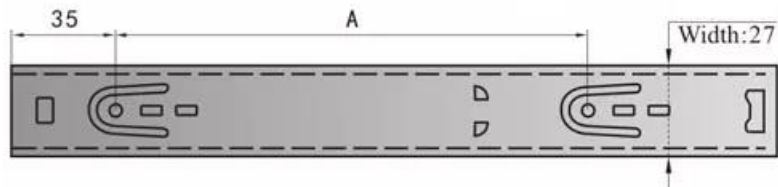
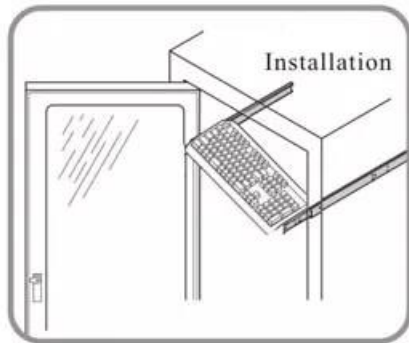

Teleskopiniai bėgeliai 27mm pločio







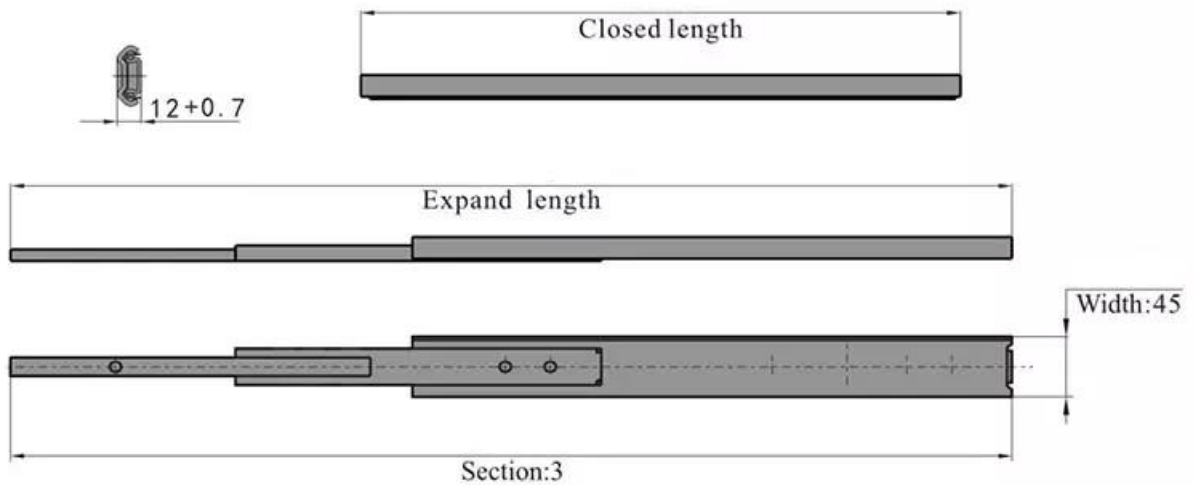
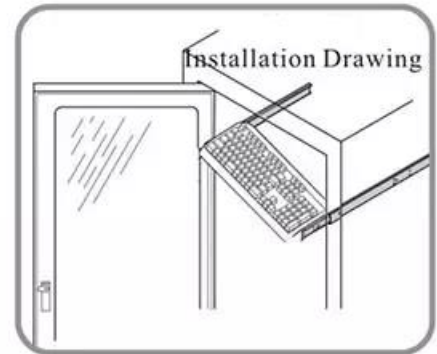

Item No.			Closed length	Expand length	Inch	A	B	E
SK5-023002710			300	500	12"	128	128	64
SK5-023502710		2D	350	583	14"	128	128	160
SK5-024002710			400	667	16"	160	160	128

 Refers to the product instructed by RoHS
  Refers to the replaceable product instructed by RoHS
  : RoHS
  : RoHS

Teleskopiniai bėgeliai 45mm pločio





Item No.			Closed length	Expand length	Inch	Thickness
SK5-033504510		2D	350	700	14"	1.0
SK5-034004510		2D	400	800	16"	1.0

 : Refers to the product instructed by RoHS
  : Refers to the replaceable product instructed by RoHS

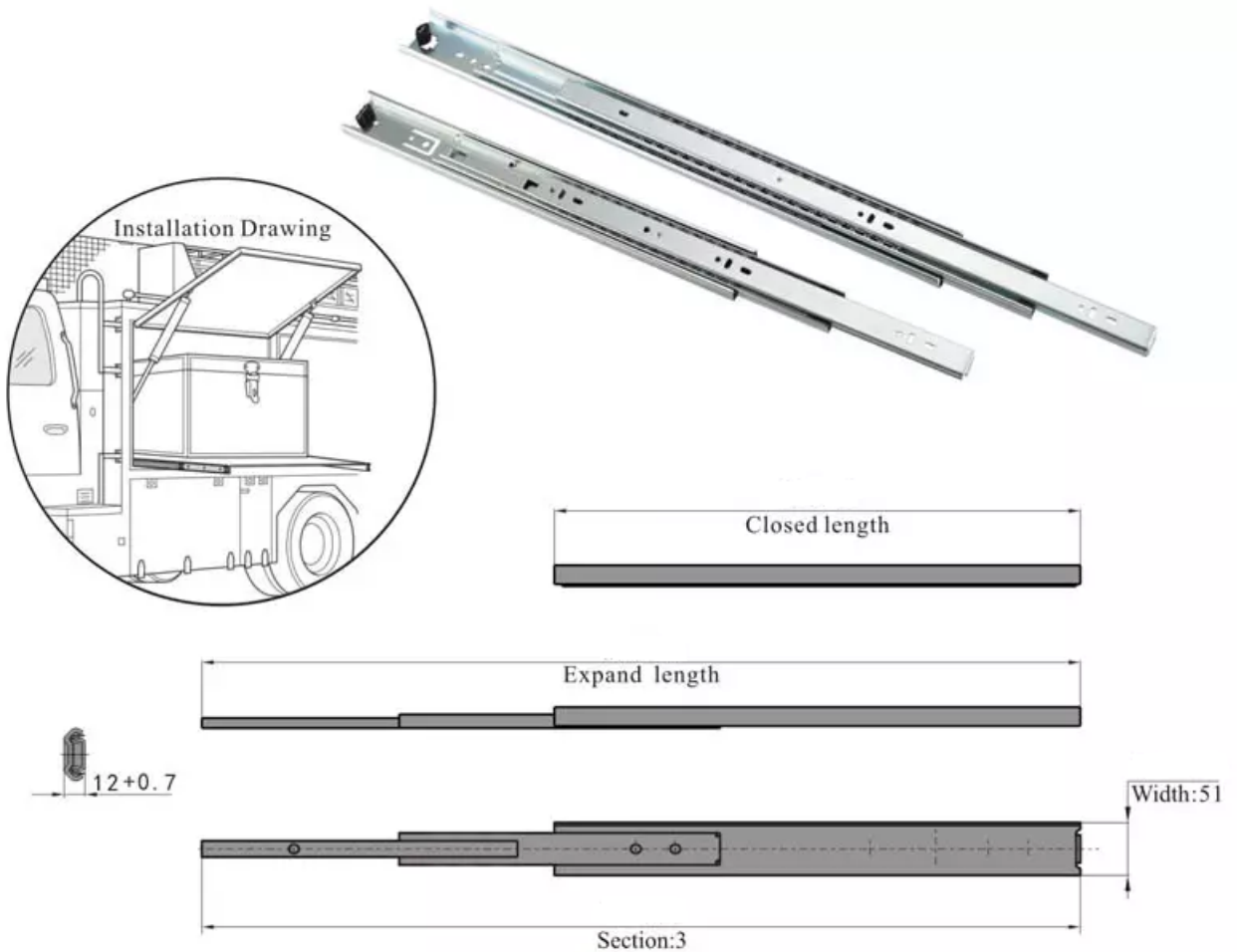
Teleskopiniai bėgeliai 51mm pločio





Item No.			Closed length	Expand length	Inch	Thickness
SK5-033055120	●	2D	305	610	12"	2.0
SK5-033565120	●	2D	356	712	14"	2.0
SK5-034575120	●	2D	457	914	18"	2.0
SK5-037115120	●	2D	711	1422	28"	2.0

● : RoHS ▲ : RoHS
 ● Refers to the product instructed by RoHS ▲ Refers to the replaceable product instructed by RoHS

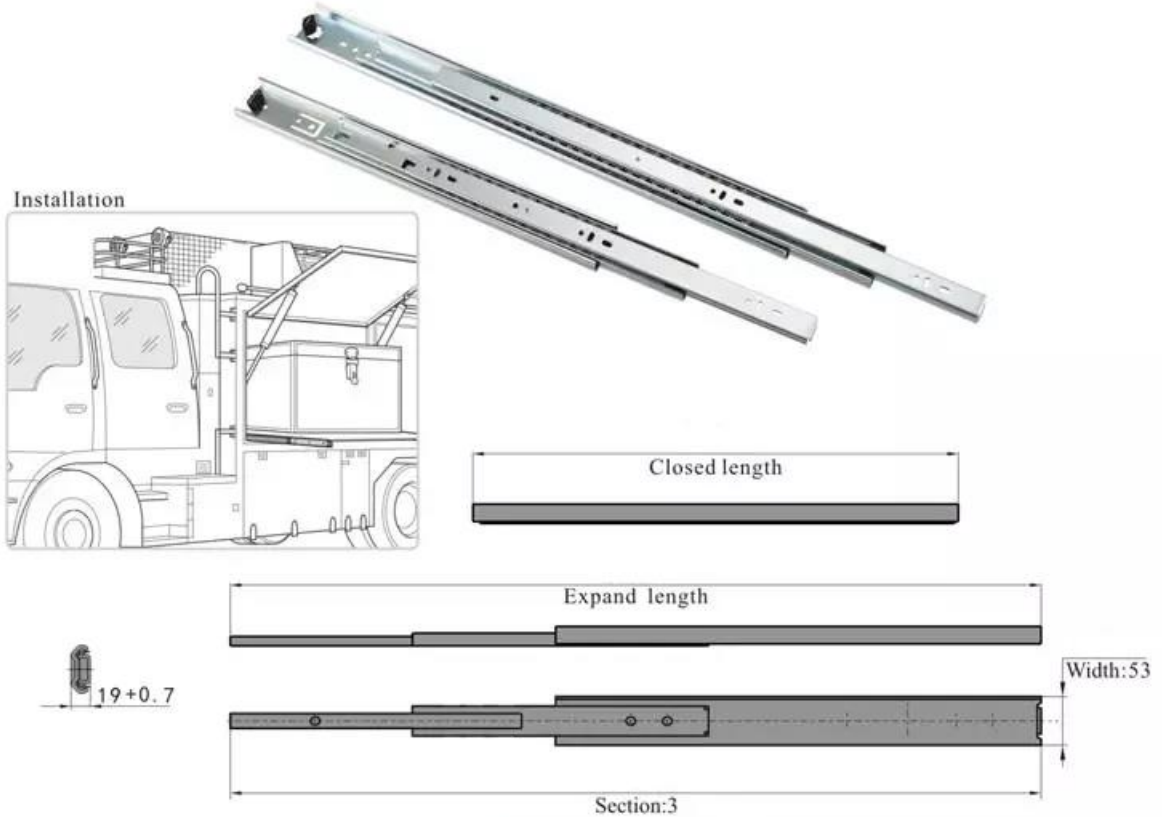
Teleskopiniai bėgeliai 53mm pločio



Item No.			Closed length	Expand length	Inch	Thickness
SK5-032545320			254	508	10"	2.0
SK5-033565320	●	2D	356	712	14"	
SK5-034575320			457	914	18"	
SK5-037625320			762	1524	30"	

● : RoHS ▲ : RoHS
 ● Refers to the product instructed by RoHS ▲ Refers to the replaceable product instructed by RoHS

Teleskopiniai bėgeliai 76mm pločio

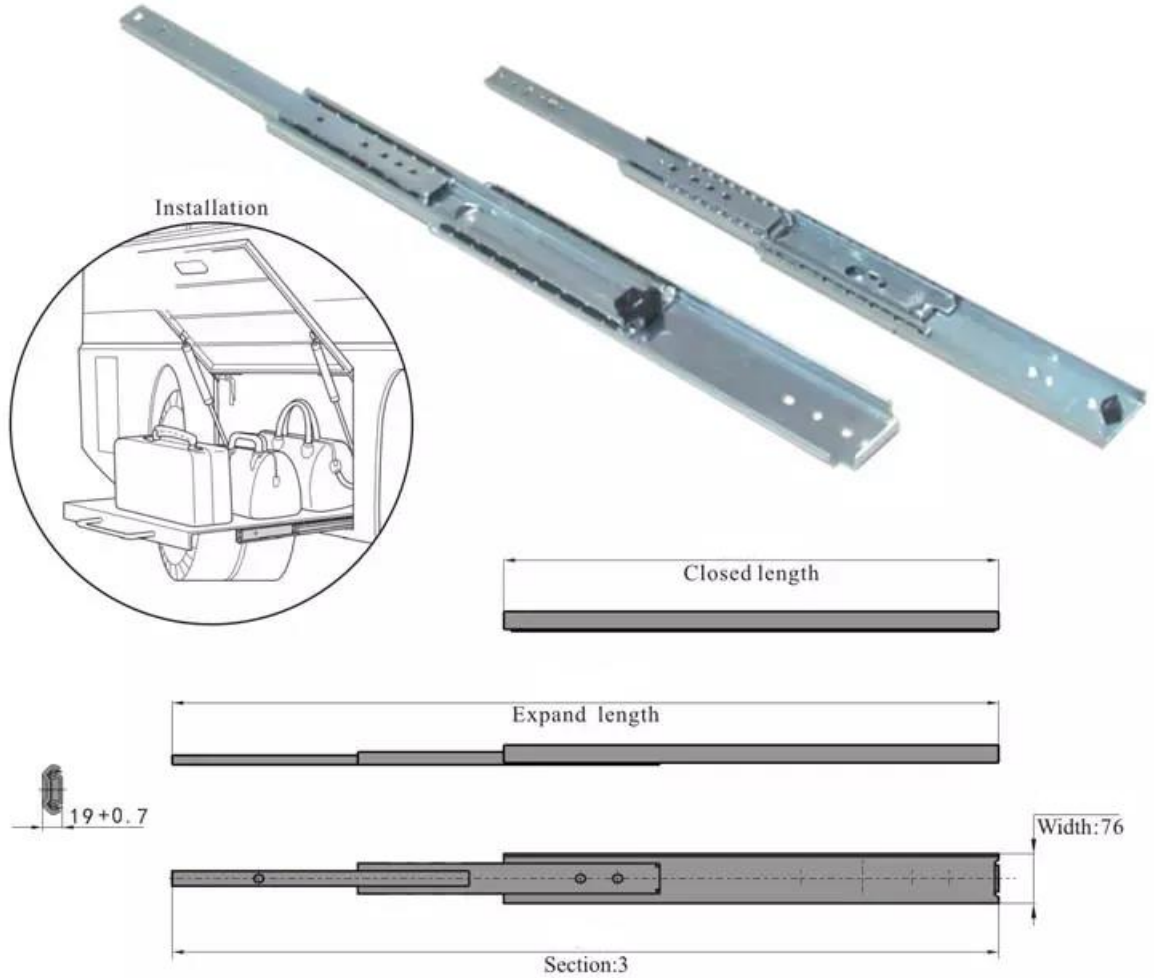

Item No.	RoHS	CAD	Closed length	Expand length	Inch	Thickness
SK5-033567625			356	712	14"	2.5
SK5-034577625	●	2D	457	914	18"	
SK5-035597625			559	1118	22"	
SK5-037627625			762	1524	30"	

● : RoHS ▲ : RoHS
 ● Refers to the product instructed by RoHS ▲ Refers to the replaceable product instructed by RoHS